

FEATURES

- 4 inputs, 1 output HDMI™/DVI links**
- Enables HDMI 1.3-compliant receiver**
- Pin-to-pin compatible with the AD8191**
- 4 TMSD[®] channels per link**
 - Supports 250 Mbps to 2.25 Gbps data rates
 - Supports 25 MHz to 225 MHz pixel clocks
 - Equalized inputs for operation with long HDMI cables (20 meters at 2.25 Gbps)
 - Fully buffered unidirectional inputs/outputs
 - Globally switchable, 50 Ω on-chip terminations
 - Pre-emphasized outputs
 - Low added jitter
- Single-supply operation (3.3 V)**
- 4 auxiliary channels per link**
 - Bidirectional unbuffered inputs/outputs
 - Flexible supply operation (3.3 V to 5 V)
 - HDCP standard compatible
 - Allows switching of DDC bus and 2 additional signals
- Multiple channel bundling modes**
 - 1× (4:1) HDMI/DVI link switch (default)
 - 2× (8:1) TMDS channel and auxiliary signal switch
 - 1× (16:1) TMDS channel and auxiliary signal switch
- Output disable feature**
 - Reduced power dissipation
 - Removable output termination
 - Allows building of larger arrays
- Two AD8197s support HDMI/DVI dual-link**
- Standards compatible: HDMI receiver, HDCP, DVI Serial (I²C[®] slave) and parallel control interface**
- 100-lead, 14 mm × 14 mm LQFP, Pb-free package**

APPLICATIONS

- Multiple input displays
- Projectors
- A/V receivers
- Set-top boxes
- Advanced television (HDTV) sets

GENERAL DESCRIPTION

The AD8197 is an HDMI/DVI switch featuring equalized TMDS inputs and pre-emphasized TMDS outputs, ideal for systems with long cable runs. Outputs can be set to a high impedance state to reduce the power dissipation and/or to allow the construction of larger arrays using the wire-OR technique. Flexible channel bundling modes (for both the TMDS channels and the auxiliary signals) allow the AD8197 to be configured as a

FUNCTIONAL BLOCK DIAGRAM

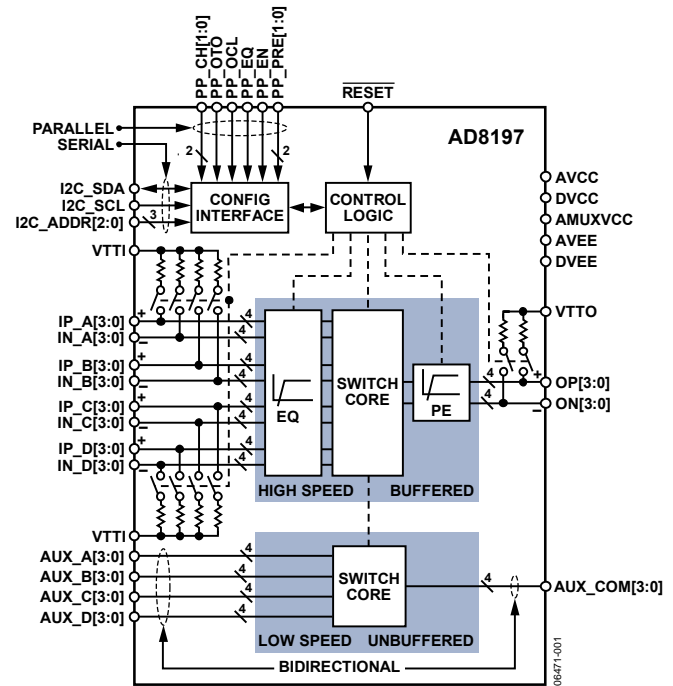

Figure 1.

TYPICAL APPLICATION

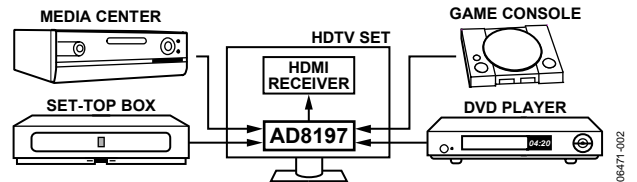

Figure 2. Typical HDTV Application

4:1 single HDMI/DVI link switch, a dual 8:1 switch, or a single 16:1 switch.

The AD8197 is provided in a 100-lead LQFP, Pb-free, surface-mount package, specified to operate over the -40°C to +85°C temperature range.

PRODUCT HIGHLIGHTS

1. Supports data rates up to 2.25 Gbps, enabling 1080p deep color (12-bit color) HDMI formats, and greater than UXGA (1600 × 1200) DVI resolutions.
2. Input cable equalizer enables use of long cables at the input (more than 20 meters of 24 AWG cable at 2.25 Gbps).
3. Auxiliary switch routes a DDC bus and two additional signals for a single-chip, HDMI 1.3 receive-compliant solution.

Rev. 0

Information furnished by Analog Devices is believed to be accurate and reliable. However, no responsibility is assumed by Analog Devices for its use, nor for any infringements of patents or other rights of third parties that may result from its use. Specifications subject to change without notice. No license is granted by implication or otherwise under any patent or patent rights of Analog Devices. Trademarks and registered trademarks are the property of their respective owners.

TABLE OF CONTENTS

Features	1	Read Procedure.....	17
Applications.....	1	Switching/Update Delay	17
General Description	1	Parallel Control Interface	18
Functional Block Diagram	1	Serial Interface Configuration Registers	19
Typical Application.....	1	High Speed Device Modes Register	19
Product Highlights	1	Auxiliary Device Modes Register	20
Revision History	2	Receiver Settings Register	22
Specifications.....	3	Input Termination Pulse Register 1 and Register 2	22
Absolute Maximum Ratings.....	5	Receive Equalizer Register 1 and Register 2	22
Thermal Resistance	5	Transmitter Settings Register.....	22
Maximum Power Dissipation	5	Parallel Interface Configuration Registers	23
ESD Caution.....	5	High Speed Device Modes Register	23
Pin Configuration and Function Descriptions.....	6	Auxiliary Device Modes Register.....	23
Typical Performance Characteristics	9	Receiver Settings Register	24
Theory of Operation	13	Input Termination Pulse Register 1 and Register 2	24
Introduction	13	Receive Equalizer Register 1 and Register 2	24
Input Channels.....	13	Transmitter Settings Register.....	24
Output Channels	13	Application Information.....	25
High Speed (TMDS) Switching Modes	14	Pinout.....	25
Auxiliary Switch.....	14	Cable Lengths and Equalization.....	25
Auxiliary (Low Speed) Switching Modes	15	PCB Layout Guidelines.....	26
Serial Control Interface.....	16	Outline Dimensions	30
Reset	16	Ordering Guide	30
Write Procedure.....	16		

REVISION HISTORY**1/07—Revision 0: Initial Version**

SPECIFICATIONS

$T_A = 27^\circ\text{C}$, $AVCC = 3.3\text{ V}$, $V_{TTI} = 3.3\text{ V}$, $V_{TTO} = 3.3\text{ V}$, $DVCC = 3.3\text{ V}$, $AMUXVCC = 5\text{ V}$, $AVEE = 0\text{ V}$, $DVEE = 0\text{ V}$, differential input swing = 1000 mV, TMDS outputs terminated with external 50 Ω resistors to 3.3 V, unless otherwise noted.

Table 1.

Parameter	Conditions/Comments	Min	Typ	Max	Unit
DYNAMIC PERFORMANCE					
Maximum Data Rate (DR) per Channel	NRZ	2.25			Gbps
Bit Error Rate (BER)	PRBS 2 ²³ – 1			10 ⁻⁹	
Added Deterministic Jitter	DR \leq 2.25 Gbps, PRBS 2 ⁷ – 1, EQ = 12 dB		25		ps (p-p)
Added Random Jitter			1		ps (rms)
Differential Intrapair Skew	At output		1		ps
Differential Interpair Skew ¹	At output		40		ps
EQUALIZATION PERFORMANCE					
Receiver (Highest Setting) ²	Boost frequency = 825 MHz		12		dB
Transmitter (Highest Setting) ³	Boost frequency = 825 MHz		6		dB
INPUT CHARACTERISTICS					
Input Voltage Swing	Differential	150		1200	mV
Input Common-Mode Voltage (V_{ICM})		AVCC – 800		AVCC	mV
OUTPUT CHARACTERISTICS					
High Voltage Level	Single-ended high speed channel	AVCC – 10		AVCC + 10	mV
Low Voltage Level	Single-ended high speed channel	AVCC – 600		AVCC – 400	mV
Rise/Fall Time (20% to 80%)		75	135	200	ps
INPUT TERMINATION					
Resistance	Single-ended		50		Ω
AUXILIARY CHANNELS					
On Resistance, R_{AUX}			100		Ω
On Capacitance, C_{AUX}	DC bias = 2.5 V, ac voltage = 3.5 V, f = 100 kHz		8		pF
Input/Output Voltage Range		DVEE		AMUXVCC	V
POWER SUPPLY					
AVCC	Operating range	3	3.3	3.6	V
QUIESCENT CURRENT					
AVCC	Outputs disabled	30	40	44	mA
	Outputs enabled, no pre-emphasis	48	60	64	mA
	Outputs enabled, maximum pre-emphasis	88	100	110	mA
VTTI	Input termination on ⁴	5	40	54	mA
VTTO	Output termination on, no pre-emphasis	35	40	46	mA
	Output termination on, maximum pre-emphasis	72	80	90	mA
DVCC		3.2	7	8	mA
AMUXVCC			0.01	0.1	mA
POWER DISSIPATION					
	Outputs disabled	115	271	361	mW
	Outputs enabled, no pre-emphasis	384	574	671	mW
	Outputs enabled, maximum pre-emphasis	704	910	1050	mW
TIMING CHARACTERISTICS					
Switching/Update Delay	High speed switching register: HS_CH			200	ms
	All other configuration registers			1.5	ms
RESET Pulse Width		50			ns

AD8197

Parameter	Conditions/Comments	Min	Typ	Max	Unit
SERIAL CONTROL INTERFACE ⁵					
Input High Voltage, V_{IH}		2			V
Input Low Voltage, V_{IL}				0.8	V
Output High Voltage, V_{OH}		2.4			V
Output Low Voltage, V_{OL}				0.4	V
PARALLEL CONTROL INTERFACE					
Input High Voltage, V_{IH}		2			V
Input Low Voltage, V_{IL}				0.8	V

¹ Differential interpair skew is measured between the TMDS pairs of a single link.

² AD8197 output meets the transmitter eye diagram as defined in the DVI Standard Revision 1.0 and the HDMI Standard Revision 1.3.

³ Cable output meets the receiver eye diagram mask as defined in the DVI Standard Revision 1.0 and the HDMI Standard Revision 1.3.

⁴ Typical value assumes only the selected HDMI/DVI link is active with nominal signal swings and that the unselected HDMI/DVI links are deactivated. Minimum and maximum limits are measured at the respective extremes of input termination resistance and input voltage swing.

⁵ The AD8197 is an I²C slave and its serial control interface is based on the 3.3 V I²C bus specification.

ABSOLUTE MAXIMUM RATINGS

Table 2.

Parameter	Rating
AVCC to AVEE	3.7 V
DVCC to DVEE	3.7 V
DVEE to AVEE	±0.3 V
VTTI	AVCC + 0.6 V
VTTO	AVCC + 0.6 V
AMUXVCC	5.5 V
Internal Power Dissipation	2.2 W
High Speed Input Voltage	AVCC – 1.4 V < V _{IN} < AVCC + 0.6 V
High Speed Differential Input Voltage	2.0 V
Low Speed Input Voltage	DVEE – 0.3 V < V _{IN} < AMUXVCC + 0.6 V
I ² C and Parallel Logic Input Voltage	DVEE – 0.3 V < V _{IN} < DVCC + 0.6 V
Storage Temperature Range	–65°C to +125°C
Operating Temperature Range	–40°C to +85°C
Junction Temperature	150°C

Stresses above those listed under Absolute Maximum Ratings may cause permanent damage to the device. This is a stress rating only; functional operation of the device at these or any other conditions above those indicated in the operational section of this specification is not implied. Exposure to absolute maximum rating conditions for extended periods may affect device reliability.

THERMAL RESISTANCE

θ_{JA} is specified for the worst-case conditions: a device soldered in a 4-layer JEDEC circuit board for surface-mount packages.

θ_{JC} is specified for no airflow.

Table 3. Thermal Resistance

Package Type	θ_{JA}	θ_{JC}	Unit
100-Lead LQFP	56	19	°C/W

MAXIMUM POWER DISSIPATION

The maximum power that can be safely dissipated by the AD8197 is limited by the associated rise in junction temperature. The maximum safe junction temperature for plastic encapsulated devices is determined by the glass transition temperature of the plastic, approximately 150°C. Temporarily exceeding this limit may cause a shift in parametric performance due to a change in the stresses exerted on the die by the package.

Exceeding a junction temperature of 175°C for an extended period can result in device failure. To ensure proper operation, it is necessary to observe the maximum power rating as determined by the coefficients in Table 3.

ESD CAUTION



ESD (electrostatic discharge) sensitive device. Charged devices and circuit boards can discharge without detection. Although this product features patented or proprietary protection circuitry, damage may occur on devices subjected to high energy ESD. Therefore, proper ESD precautions should be taken to avoid performance degradation or loss of functionality.

PIN CONFIGURATION AND FUNCTION DESCRIPTIONS

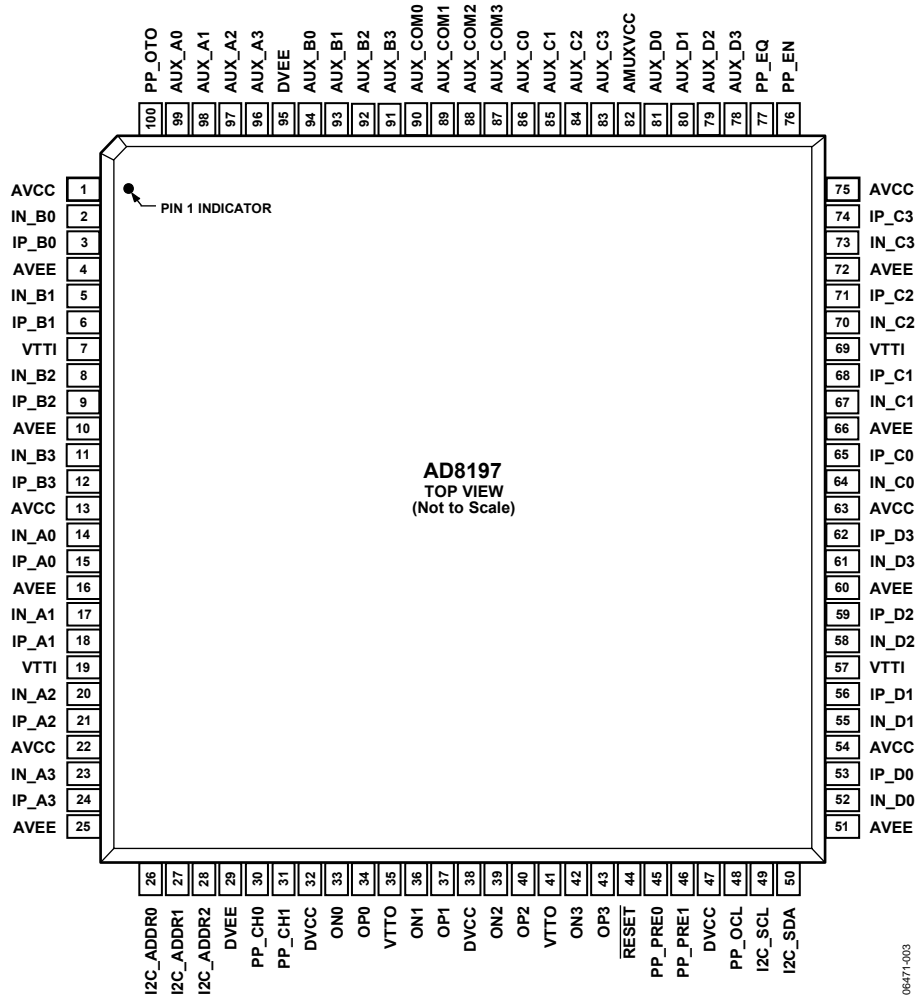

Figure 3. Pin Configuration

06471-003

Table 4. Pin Function Descriptions

Pin No.	Mnemonic	Type ¹	Description
1, 13, 22, 54, 63, 75	AVCC	Power	Positive Analog Supply. 3.3 V nominal.
2	IN_B0	HS I	High Speed Input Complement.
3	IP_B0	HS I	High Speed Input.
4, 10, 16, 25, 51, 60, 66, 72	AVEE	Power	Negative Analog Supply. 0 V nominal.
5	IN_B1	HS I	High Speed Input Complement.
6	IP_B1	HS I	High Speed Input.
7, 19, 57, 69	VTTI	Power	Input Termination Supply. Nominally connected to AVCC.
8	IN_B2	HS I	High Speed Input Complement.
9	IP_B2	HS I	High Speed Input.
11	IN_B3	HS I	High Speed Input Complement.
12	IP_B3	HS I	High Speed Input.
14	IN_A0	HS I	High Speed Input Complement.
15	IP_A0	HS I	High Speed Input.
17	IN_A1	HS I	High Speed Input Complement.
18	IP_A1	HS I	High Speed Input.
20	IN_A2	HS I	High Speed Input Complement.
21	IP_A2	HS I	High Speed Input.
23	IN_A3	HS I	High Speed Input Complement.

Pin No.	Mnemonic	Type ¹	Description
24	IP_A3	HS I	High Speed Input.
26	I2C_ADDR0	Control	I ² C Address 1 st LSB.
27	I2C_ADDR1	Control	I ² C Address 2 nd LSB.
28	I2C_ADDR2	Control	I ² C Address 3 rd LSB.
29, 95	DVEE	Power	Negative Digital and Auxiliary Multiplexer Power Supply. 0 V nominal.
30	PP_CH0	Control	Quad Switching Mode High Speed Source Selection Parallel Interface LSB.
31	PP_CH1	Control	Quad Switching Mode High Speed Source Selection Parallel Interface MSB.
32, 38, 47	DVCC	Power	Positive Digital Power Supply. 3.3 V nominal.
33	ON0	HS O	High Speed Output Complement.
34	OP0	HS O	High Speed Output.
35, 41	VTTO	Power	Output Termination Supply. Nominally connected to AVCC.
36	ON1	HS O	High Speed Output Complement.
37	OP1	HS O	High Speed Output.
39	ON2	HS O	High Speed Output Complement.
40	OP2	HS O	High Speed Output.
42	ON3	HS O	High Speed Output Complement.
43	OP3	HS O	High Speed Output.
44	RESET	Control	Configuration Registers Reset. Normally pulled up to AVCC.
45	PP_PRE0	Control	High Speed Pre-Emphasis Selection Parallel Interface LSB.
46	PP_PRE1	Control	High Speed Pre-Emphasis Selection Parallel Interface MSB.
48	PP_OCL	Control	High Speed Output Current Level Parallel Interface.
49	I2C_SCL	Control	I ² C Clock.
50	I2C_SDA	Control	I ² C Data.
52	IN_D0	HS I	High Speed Input Complement.
53	IP_D0	HS I	High Speed Input.
55	IN_D1	HS I	High Speed Input Complement.
56	IP_D1	HS I	High Speed Input.
58	IN_D2	HS I	High Speed Input Complement.
59	IP_D2	HS I	High Speed Input.
61	IN_D3	HS I	High Speed Input Complement.
62	IP_D3	HS I	High Speed Input.
64	IN_C0	HS I	High Speed Input Complement.
65	IP_C0	HS I	High Speed Input.
67	IN_C1	HS I	High Speed Input Complement.
68	IP_C1	HS I	High Speed Input.
70	IN_C2	HS I	High Speed Input Complement.
71	IP_C2	HS I	High Speed Input.
73	IN_C3	HS I	High Speed Input Complement.
74	IP_C3	HS I	High Speed Input.
76	PP_EN	Control	High Speed Output Enable Parallel Interface.
77	PP_EQ	Control	High Speed Equalization Selection Parallel Interface.
78	AUX_D3	LS I/O	Low Speed Input/Output.
79	AUX_D2	LS I/O	Low Speed Input/Output.
80	AUX_D1	LS I/O	Low Speed Input/Output.
81	AUX_D0	LS I/O	Low Speed Input/Output.
82	AMUXVCC	Power	Positive Auxiliary Multiplexer Supply. 5 V typical.
83	AUX_C3	LS I/O	Low Speed Input/Output.
84	AUX_C2	LS I/O	Low Speed Input/Output.
85	AUX_C1	LS I/O	Low Speed Input/Output.
86	AUX_C0	LS I/O	Low Speed Input/Output.
87	AUX_COM3	LS I/O	Low Speed Common Input/Output.
88	AUX_COM2	LS I/O	Low Speed Common Input/Output.
89	AUX_COM1	LS I/O	Low Speed Common Input/Output.

AD8197

Pin No.	Mnemonic	Type ¹	Description
90	AUX_COM0	LS I/O	Low Speed Common Input/Output.
91	AUX_B3	LS I/O	Low Speed Input/Output.
92	AUX_B2	LS I/O	Low Speed Input/Output.
93	AUX_B1	LS I/O	Low Speed Input/Output.
94	AUX_B0	LS I/O	Low Speed Input/Output.
96	AUX_A3	LS I/O	Low Speed Input/Output.
97	AUX_A2	LS I/O	Low Speed Input/Output.
98	AUX_A1	LS I/O	Low Speed Input/Output.
99	AUX_A0	LS I/O	Low Speed Input/Output.
100	PP_OTO	Control	High Speed Output Termination Selection Parallel Interface.

¹ HS = high speed, LS = low speed, I = input, O = output.

TYPICAL PERFORMANCE CHARACTERISTICS

$T_A = 27^\circ\text{C}$, $AVCC = 3.3\text{ V}$, $V_{TTI} = 3.3\text{ V}$, $V_{TTO} = 3.3\text{ V}$, $DVCC = 3.3\text{ V}$, $AMUXVCC = 5\text{ V}$, $AVEE = 0\text{ V}$, $DVEE = 0\text{ V}$, differential input swing = 1000 mV, TMDS outputs terminated with external 50 Ω resistors to 3.3 V, pattern = PRBS $2^7 - 1$, data rate = 2.25 Gbps, unless otherwise noted.

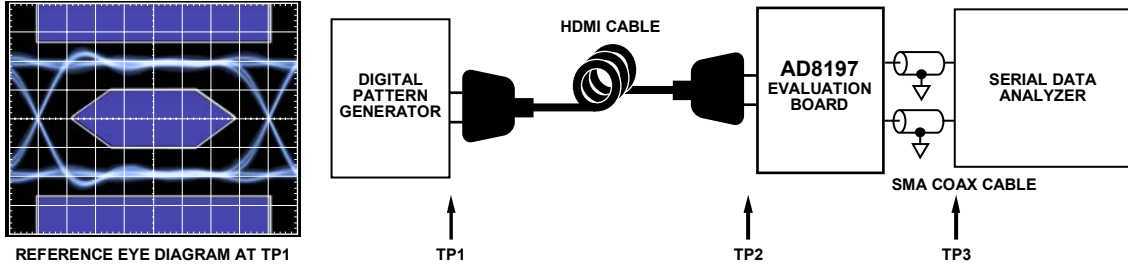

Figure 4. Test Circuit Diagram for RX Eye Diagram

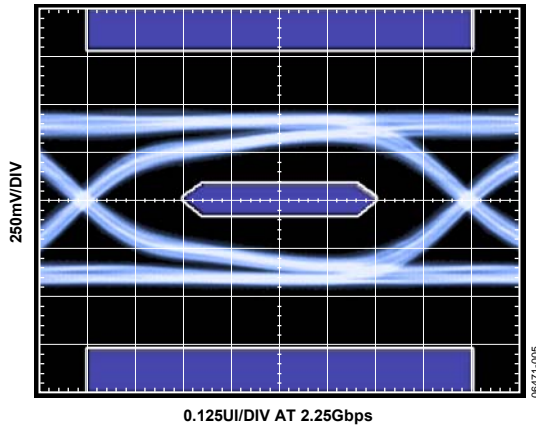

Figure 5. RX Eye Diagram at TP2 (Cable = 2 meters, 30 AWG)

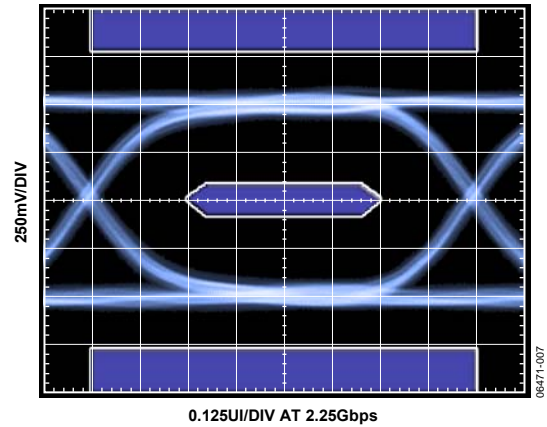

Figure 7. RX Eye Diagram at TP3, EQ = 6 dB (Cable = 2 meters, 30 AWG)

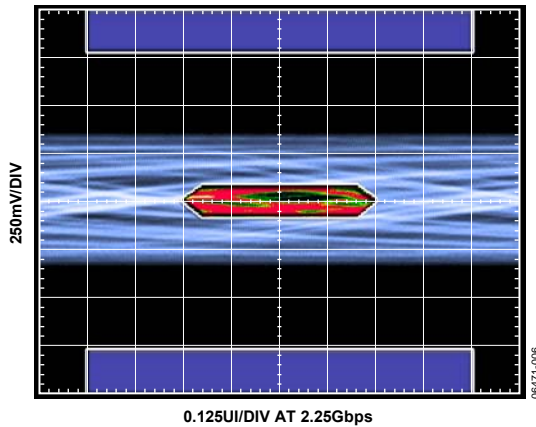

Figure 6. RX Eye Diagram at TP2 (Cable = 20 meters, 24 AWG)

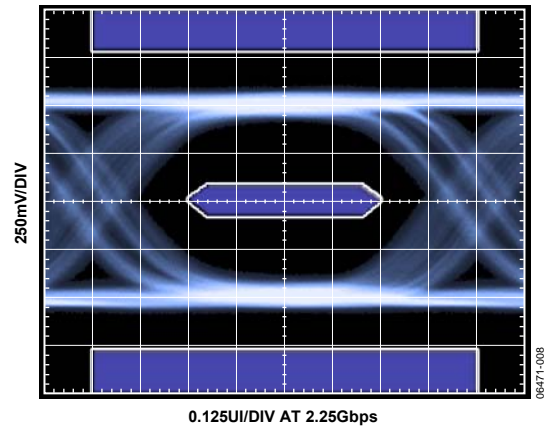

Figure 8. RX Eye Diagram at TP3, EQ = 12 dB (Cable = 20 meters, 24 AWG)

AD8197

$T_A = 27^\circ\text{C}$, $AVCC = 3.3\text{ V}$, $VTTI = 3.3\text{ V}$, $VTTO = 3.3\text{ V}$, $DVCC = 3.3\text{ V}$, $AMUXVCC = 5\text{ V}$, $AVEE = 0\text{ V}$, $DVEE = 0\text{ V}$, differential input swing = 1000 mV, TMDS outputs terminated with external $50\ \Omega$ resistors to 3.3 V, pattern = PRBS $2^7 - 1$, data rate = 2.25 Gbps, unless otherwise noted.

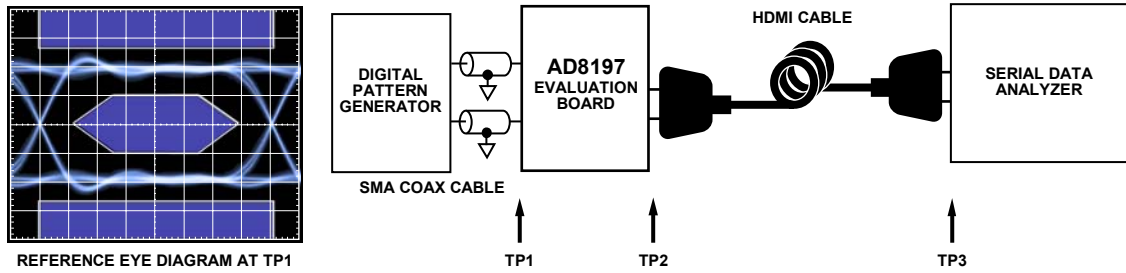

Figure 9. Test Circuit Diagram for TX Eye Diagrams

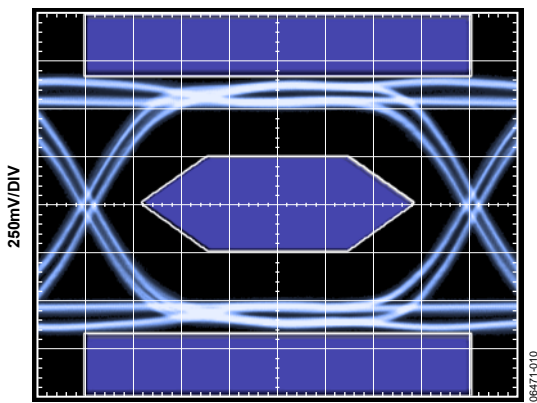

Figure 10. TX Eye Diagram at TP2, PE = 2 dB

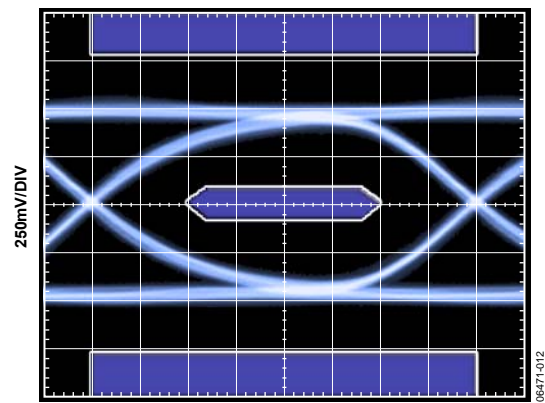

Figure 12. TX Eye Diagram at TP3, PE = 2 dB (Cable = 2 meters, 30 AWG)

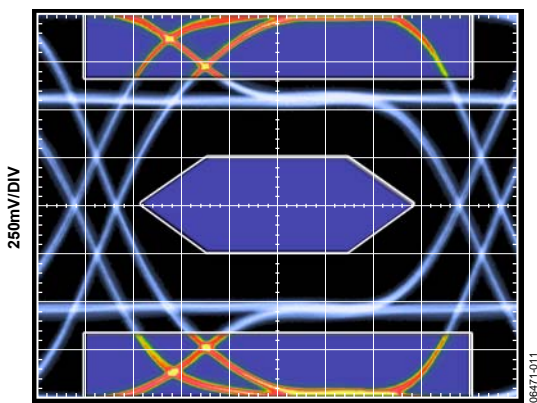

Figure 11. TX Eye Diagram at TP2, PE = 6 dB

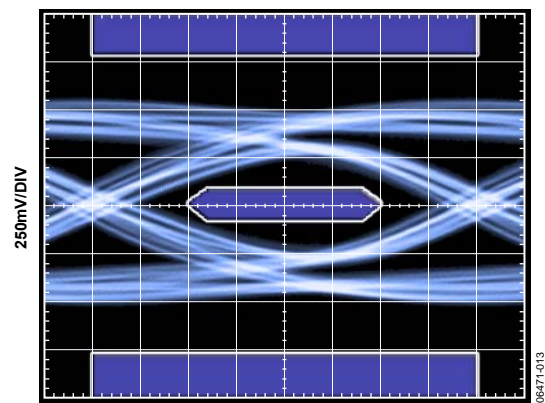

Figure 13. TX Eye Diagram at TP3, PE = 6 dB (Cable = 10 meters, 28 AWG)

T_A = 27°C, AVCC = 3.3 V, VTTI = 3.3 V, VTTO = 3.3 V, DVCC = 3.3 V, AMUXVCC = 5 V, AVEE = 0 V, DVEE = 0 V, differential input swing = 1000 mV, TMDS outputs terminated with external 50 Ω resistors to 3.3 V, pattern = PRBS 2⁷ - 1, data rate = 2.25 Gbps, unless otherwise noted.

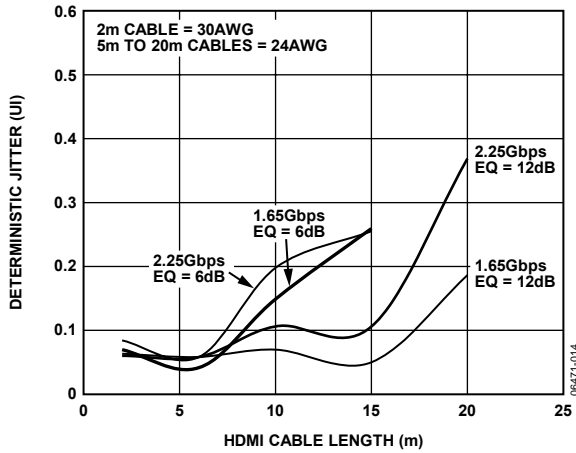

Figure 14. Jitter vs. Input Cable Length (See Figure 4 for Test Setup)

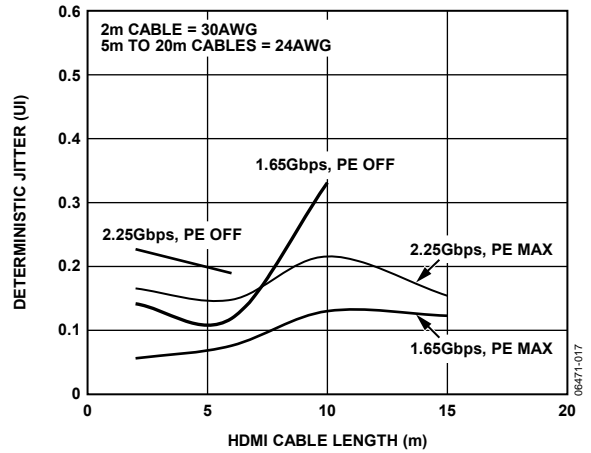

Figure 17. Jitter vs. Output Cable Length (See Figure 9 for Test Setup)

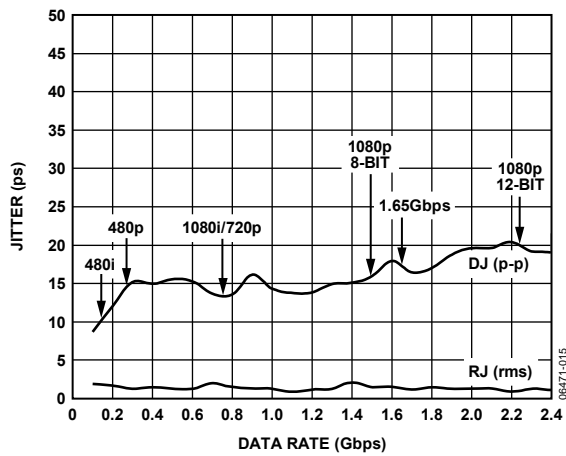

Figure 15. Jitter vs. Data Rate

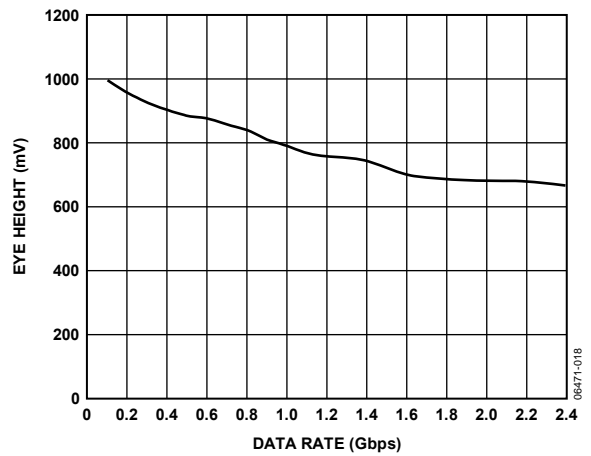

Figure 18. Eye Height vs. Data Rate

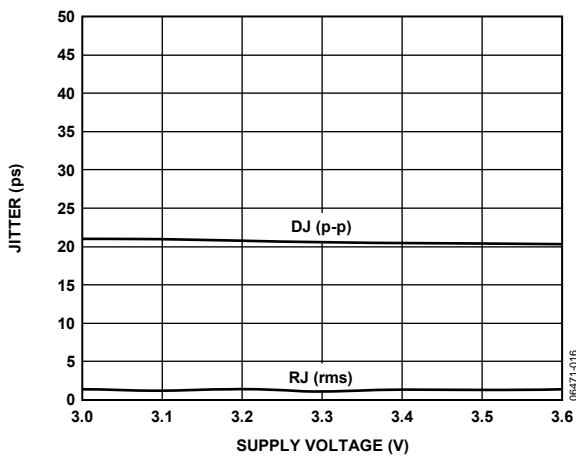

Figure 16. Jitter vs. Supply Voltage

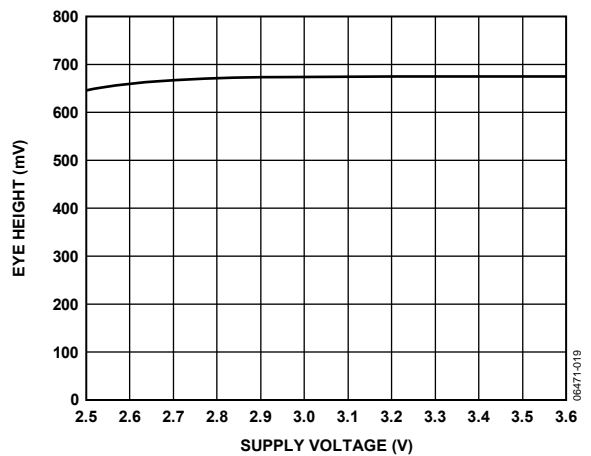

Figure 19. Eye Height vs. Supply Voltage

AD8197

$T_A = 27^\circ\text{C}$, $AVCC = 3.3\text{ V}$, $V_{TTI} = 3.3\text{ V}$, $V_{TTO} = 3.3\text{ V}$, $DVCC = 3.3\text{ V}$, $AMUXVCC = 5\text{ V}$, $AVEE = 0\text{ V}$, $DVEE = 0\text{ V}$, differential input swing = 1000 mV, TMDS outputs terminated with external $50\ \Omega$ resistors to 3.3 V, pattern = PRBS $2^7 - 1$, data rate = 2.25 Gbps, unless otherwise noted.

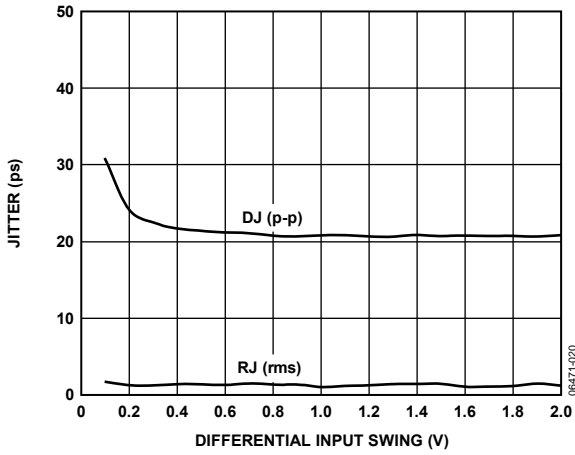

Figure 20. Jitter vs. Differential Input Swing

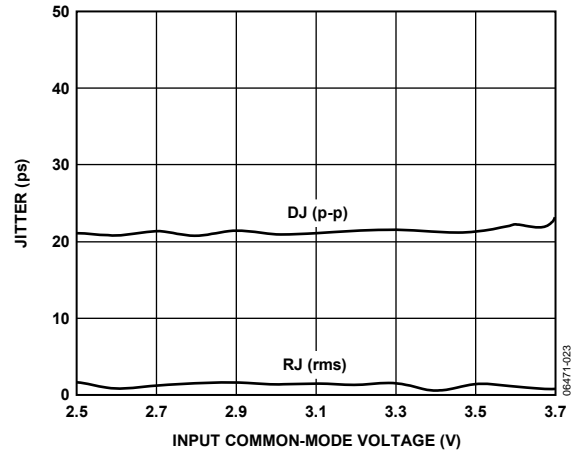

Figure 23. Jitter vs. Input Common-Mode Voltage

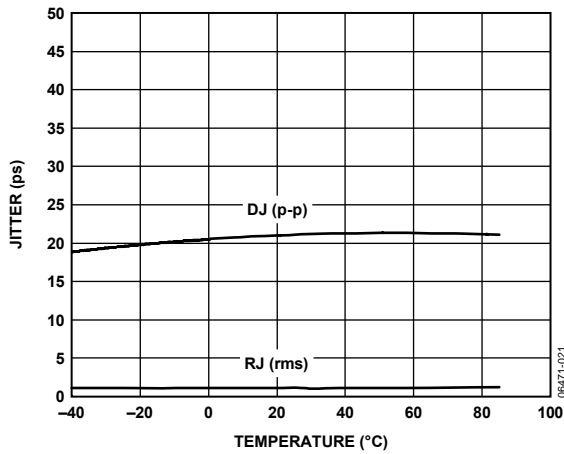

Figure 21. Jitter vs. Temperature

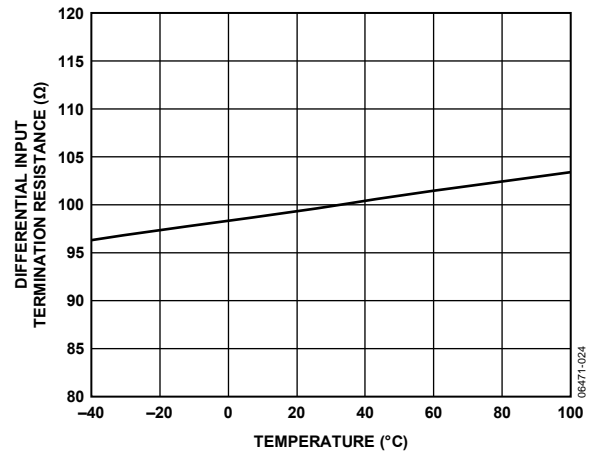

Figure 24. Differential Input Termination Resistance vs. Temperature

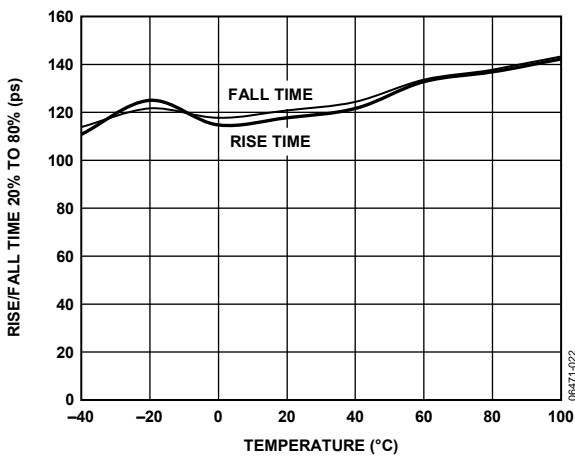

Figure 22. Rise and Fall Time vs. Temperature

THEORY OF OPERATION

INTRODUCTION

The AD8197 is a pin-to-pin HDMI 1.3 receive-compliant replacement for the AD8191. The primary function of the AD8197 is to switch one of four (HDMI or DVI) single-link sources to one output. Each HDMI/DVI link consists of four differential, high speed channels and four auxiliary single-ended, low speed control signals. The high speed channels include a data-word clock and three transition minimized differential signaling (TMDS) data channels running at 10× the data-word clock frequency for data rates up to 2.25 Gbps. The four low speed control signals are 5 V tolerant bidirectional lines that can carry configuration signals, HDCP encryption, and other information, depending upon the specific application.

All four high speed TMDS channels in a given link are identical; that is, the pixel clock can be run on any of the four TMDS channels. Transmit and receive channel compensation is provided for the high speed channels where the user can (manually) select among a number of fixed settings.

The AD8197 switching logic has three modes: quad mode (a quad 4:1 switch), dual mode (a dual 8:1 switch), and single mode (one 16:1 switch).

The AD8197 has two control interfaces. Users have the option of controlling the part through either the parallel control interface or the I²C serial control interface. The AD8197 has eight user-programmable I²C slave addresses to allow multiple AD8197s to be controlled by a single I²C bus. A RESET pin is provided to restore the control registers of the AD8197 to default values. In all cases, serial programming values override any prior parallel programming values and any use of the serial control interface disables the parallel control interface until the AD8197 is reset.

When using the serial control interface, all three switching modes (quad, dual, and single) are accessible and the high speed channel switching mode is controlled independently of the auxiliary signal switching mode. When using the parallel control interface, only the quad switching mode is accessible, and the same channel select bus (PP_CH[1:0]) simultaneously switches both the high speed channels and the auxiliary signals.

INPUT CHANNELS

Each high speed input differential pair terminates to the 3.3 V VTTI power supply through a pair of single-ended 50 Ω on-chip resistors, as shown in Figure 25. The input terminations can be optionally disconnected for approximately 100 ms following a source switch. The user can program which of the 16 high speed input channels employs this feature by selectively programming the associated RX_PT bits in the input termination pulse register through the serial control interface. Additionally, all the input terminations can be disconnected by programming the RX_TO bit in the receiver settings register. By default, the

input termination is enabled. The input terminations are enabled and cannot be switched when programming the AD8197 through the parallel control interface.

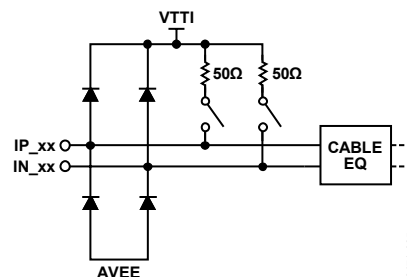

Figure 25. High Speed Input Simplified Schematic

The input equalizer can be manually configured to provide two different levels of high frequency boost: 6 dB or 12 dB. The user can individually control the equalization level of the eight high speed input channels by selectively programming the associated RX_EQ bits in the receive equalizer register through the serial control interface. Alternately, the user can globally control the equalization level of all eight high speed input channels by setting the PP_EQ pin of the parallel control interface. No specific cable length is suggested for a particular equalization setting because cable performance varies widely between manufacturers; however, in general, the equalization of the AD8197 can be set to 12 dB without degrading the signal integrity, even for short input cables. At the 12 dB setting, the AD8197 can equalize more than 20 meters of 24 AWG cable at 2.25 Gbps.

OUTPUT CHANNELS

Each high speed output differential pair is terminated to the 3.3 V VTTO power supply through two 50 Ω on-chip resistors (see Figure 26). This termination is user-selectable; it can be turned on or off by programming the TX_PTO bit of the transmitter settings register through the serial control interface, or by setting the PP_OTO pin of the parallel control interface.

The output termination resistors of the AD8197 back-terminate the output TMDS transmission lines. These back-terminations, as recommended in the HDMI 1.3 specification, act to absorb reflections from impedance discontinuities on the output traces, improving the signal integrity of the output traces and adding flexibility to how the output traces can be routed. For example, interlayer vias can be used to route the AD8197 TMDS outputs on multiple layers of the PCB without severely degrading the quality of the output signal.

The AD8197 output has a disable feature that places the outputs in a tristate mode. This mode is enabled by programming the HS_EN bit of the high speed device modes register through the serial control interface or by setting the PP_EN pin of the parallel control interface. Larger wire-OR'ed arrays can be constructed using the AD8197 in this mode.

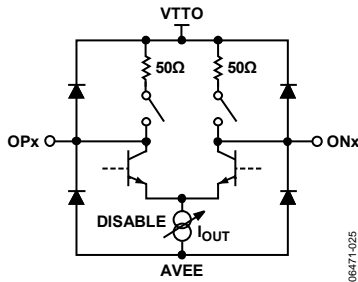

Figure 26. High Speed Output Simplified Schematic

The AD8197 requires output termination resistors when the high speed outputs are enabled. Termination can be internal and/or external. The internal terminations of the AD8197 are enabled by programming the TX_PTO bit of the transmitter settings register or by setting the PP_OTO pin of the parallel control interface. The internal terminations of the AD8197 default to the setting indicated by PP_OTO upon reset. External terminations can be provided either by on-board resistors or by the input termination resistors of an HDMI/DVI receiver. If both the internal terminations are enabled and external terminations are present, set the output current level to 20 mA by programming the TX_OCL bit of the transmitter settings register through the serial control interface or by setting the PP_OCL pin of the parallel control interface. The output current level defaults to the level indicated by PP_OCL upon reset. If only external terminations are provided (if the internal terminations are disabled), set the output current level to 10 mA by programming the TX_OCL bit of the transmitter settings register or by setting the PP_OCL pin of the parallel control interface. The high speed outputs must be disabled if there are no output termination resistors present in the system.

The output pre-emphasis can be manually configured to provide one of four different levels of high frequency boost. The specific boost level is selected by programming the TX_PE bits of the transmitter settings register through the serial control interface, or by setting the PP_PE bus of the parallel control interface. No specific cable length is suggested for a particular pre-emphasis setting because cable performance varies widely between manufacturers.

HIGH SPEED (TMDS) SWITCHING MODES

The AD8197 has three high speed switching modes: quad, dual, and single. These are selected by programming the HS_SM bits of the high speed device modes register through the serial control interface.

Quad Switching Mode

This is the default mode. In quad mode, the AD8197 behaves like a 4:1 HDMI/DVI link multiplexer routing groups of four TMDS input channels to the four-channel output. This mode is accessible through both the serial and the parallel control interfaces. When using the serial control interface, select which TMDS link is routed to the output by programming the HS_CH bits of the high speed device modes register in accordance with the switch mapping listed in Table 8. When using the parallel

control interface, select which TMDS link is routed to the output by setting the PP_CH bus of the parallel control interface in accordance with the switch mapping listed in Table 26.

Dual Switching Mode

In this mode, the AD8197 behaves as a locked dual [8:1] TMDS channel switch. The two 8:1 switches share the channel select input and, therefore, switch together. Select which two out of the eight possible input groups are routed to output by programming the HS_CH bits of the high speed device modes register in accordance with the switch mapping listed in Table 9. This mode is only accessible through the serial control interface.

Single Switching Mode

In this mode, the AD8197 behaves as a single 16:1 TMDS channel multiplexer; one of the 16 input channels is routed to all of the outputs. Select which input channel is routed to the outputs by programming the HS_CH bits in the high speed device modes register in accordance with the switch mapping listed in Table 10. This mode is only accessible through the serial control interface.

AUXILIARY SWITCH

The auxiliary (low speed) lines have no amplification. They are routed using a passive switch that is bandwidth compatible with standard speed I²C. The schematic equivalent for this passive connection is shown in Figure 27.

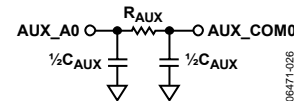

Figure 27. Auxiliary Channel Simplified Schematic, AUX_A0 to AUX_COM0 Routing Example

When turning off the AD8197, care needs to be taken with the AMUXVCC supply to ensure that the auxiliary multiplexer pins remain in a high impedance state. A scenario that illustrates this requirement is one where the auxiliary multiplexer is used to switch the display data channel (DDC) bus. In some applications, additional devices can be connected to the DDC bus (such as an EEPROM with EDID information) upstream of the AD8197. Extended display identification data (EDID) is a VESA standard-defined data format for conveying display configuration information to sources to optimize display use. EDID devices may need to be available via the DDC bus, regardless of the state of the AD8197 and any downstream circuit. For this configuration, the auxiliary inputs of the powered down AD8197 need to be in a high impedance state to avoid pulling down on the DDC lines and preventing these other devices from using the bus.

When the AD8197 is powered from a simple resistor network, as shown in Figure 28, it uses the 5 V supply that is required from any HDMI/DVI source to guarantee high impedance of the auxiliary multiplexer pins. The AMUXVCC supply does not draw any static current; therefore, it is recommended that the resistor network tap the 5 V supplies as close to the connectors as possible to avoid any additional voltage drop.

This precaution does not need to be taken if the DDC peripheral circuitry is connected to the bus downstream of the AD8197.

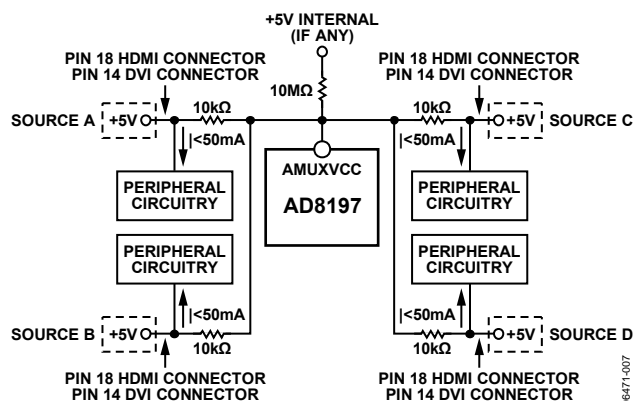

Figure 28. Suggested AMUXVCC Power Scheme

AUXILIARY (LOW SPEED) SWITCHING MODES

The AD8197 has three auxiliary switching modes: quad, dual, and single. These are selected by programming the AUX_SM bits of the auxiliary device modes register through the serial control interface. The auxiliary switching mode is independent of the high speed switching mode whenever the part is controlled through the serial control interface. When the part is controlled through the parallel control interface, however, only quad mode is accessible and the auxiliary switching mode cannot be independently controlled.

Quad Switching Mode

This is the default mode. In quad mode, the AD8197 behaves like a 4:1 auxiliary link multiplexer, routing groups of four auxiliary input signals to the four-signal output. Select which group of inputs is routed to the output by programming the AUX_CH bits of the auxiliary device modes register through the serial control interface in accordance with the switch mapping listed in Table 13. Alternately, select which group of inputs is routed to the output by setting the PP_CH bus of the parallel control interface in accordance with the switch mapping listed in Table 27.

Dual Switching Mode

In this mode, the AD8197 behaves as a locked dual [8:1] auxiliary signal switch. The two 8:1 switches share the channel select input and, therefore, switch together. Select which two out of the eight possible input groups are routed to the output by programming the AUX_CH bits of the auxiliary device modes register in accordance with the switch mapping listed in Table 14. This mode is only accessible through the serial control interface.

Single Switching Mode

In this mode the AD8197 behaves as a single 16:1 TMDS channel multiplexer; a single channel, out of a possible 16, is routed to all of the outputs. Select which input channel is routed to the outputs by programming the AUX_CH bits of the auxiliary device modes register in accordance with the switch mapping listed in Table 15. This mode is only accessible through the serial control interface.

SERIAL CONTROL INTERFACE

RESET

On initial power-up, or at any point in operation, the AD8197 register set can be restored to preprogrammed default values by pulling the **RESET** pin to low in accordance with the specifications in Table 1. During normal operation, however, the **RESET** pin must be pulled up to 3.3 V. Following a reset, the preprogrammed default values of the AD8197 register set correspond to the state of the parallel interface configuration registers, as listed in Table 24. The AD8197 can be controlled through the parallel control interface until the first serial control event occurs. As soon as any serial control event occurs, the serial programming values, corresponding to the state of the serial interface configuration registers (Table 5), override any prior parallel programming values, and the parallel control interface is disabled until the part is subsequently reset.

WRITE PROCEDURE

To write data to the AD8197 register set, an I²C master (such as a microcontroller) needs to send the appropriate control signals to the AD8197 slave device. The signals are controlled by the I²C master, unless otherwise specified. For a diagram of the procedure, see Figure 29. The steps for a write procedure are as follows:

1. Send a start condition (while holding the I2C_SCL line high, pull the I2C_SDA line low).
2. Send the AD8197 part address (seven bits). The upper four bits of the AD8197 part address are the static value [1001] and the three LSBs are set by Input Pin I2C_ADDR2, Input Pin I2C_ADDR1, and Input Pin I2C_ADDR0 (LSB). This transfer should be MSB first.
3. Send the write indicator bit (0).

4. Wait for the AD8197 to acknowledge the request.
5. Send the register address (eight bits) to which data is to be written. This transfer should be MSB first.
6. Wait for the AD8197 to acknowledge the request.
7. Send the data (eight bits) to be written to the register whose address was set in Step 5. This transfer should be MSB first.
8. Wait for the AD8197 to acknowledge the request.
9. Perform one of the following:
 - 9a. Send a stop condition (while holding the I2C_SCL line high, pull the I2C_SDA line high) and release control of the bus to end the transaction (shown in Figure 29).
 - 9b. Send a repeated start condition (while holding the I2C_SCL line high, pull the I2C_SDA line low) and continue with Step 2 in this procedure to perform another write.
 - 9c. Send a repeated start condition (while holding the I2C_SCL line high, pull the I2C_SDA line low) and continue with Step 2 of the read procedure (in the Read Procedure section) to perform a read from another address.
 - 9d. Send a repeated start condition (while holding the I2C_SCL line high, pull the I2C_SDA line low) and continue with Step 8 of the read procedure (in the Read Procedure section) to perform a read from the same address set in Step 5.

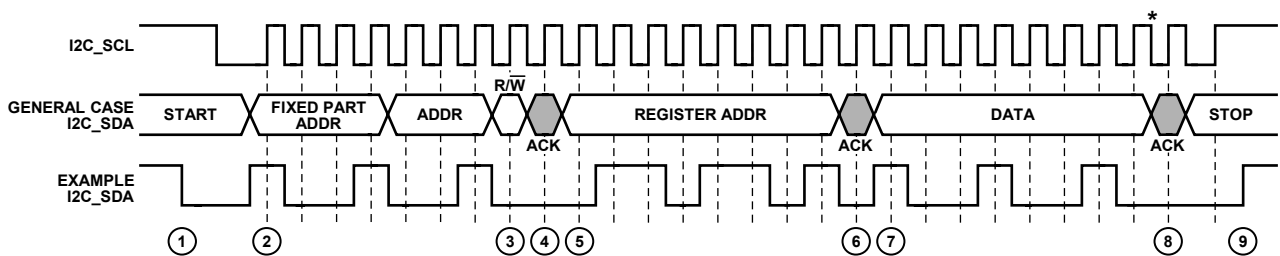

*THE SWITCHING/UPDATE DELAY BEGINS AT THE FALLING EDGE OF THE LAST DATA BIT; FOR EXAMPLE, THE FALLING EDGE JUST BEFORE STEP 8.

Figure 29. I²C Write Diagram

06471-028

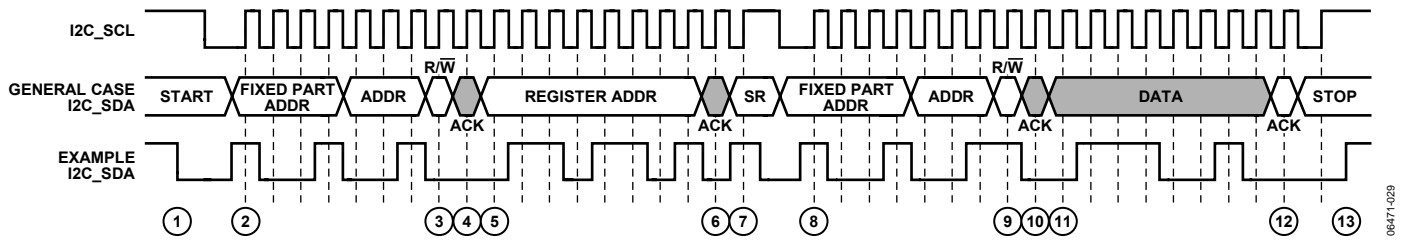
Figure 30. I²C Read Diagram

READ PROCEDURE

To read data from the AD8197 register set, an I²C master (such as a microcontroller) needs to send the appropriate control signals to the AD8197 slave device. The signals are controlled by the I²C master, unless otherwise specified. For a diagram of the procedure, see Figure 30. The steps for a read procedure are as follows:

1. Send a start condition (while holding the I2C_SCL line high, pull the I2C_SDA line low).
2. Send the AD8197 part address (seven bits). The upper four bits of the AD8197 part address are the static value [1001] and the three LSBs are set by Input Pin I2C_ADDR2, Input Pin I2C_ADDR1, and Input Pin I2C_ADDR0 (LSB). This transfer should be MSB first.
3. Send the write indicator bit (0).
4. Wait for the AD8197 to acknowledge the request.
5. Send the register address (eight bits) from which data is to be read. This transfer should be MSB first.
6. Wait for the AD8197 to acknowledge the request.
7. Send a repeated start condition (Sr) by holding the I2C_SCL line high and pulling the I2C_SDA line low.
8. Resend the AD8197 part address (seven bits) from Step 2. The upper four bits of the AD8197 part address are the static value [1001] and the three LSBs are set by the Input Pin I2C_ADDR2, I2C_ADDR1 and Input Pin I2C_ADDR0 (LSB). This transfer should be MSB first.
9. Send the read indicator bit (1).
10. Wait for the AD8197 to acknowledge the request.
11. The AD8197 serially transfers the data (eight bits) held in the register indicated by the address set in Step 5. This data is sent MSB first.
12. Acknowledge the data from the AD8197.
13. Perform one of the following:
 - 13a. Send a stop condition (while holding the I2C_SCL line high, pull the SDA line high) and release control of the bus to end the transaction (shown in Figure 30).
 - 13b. Send a repeated start condition (while holding the I2C_SCL line high, pull the I2C_SDA line low) and continue with Step 2 of the write procedure (previous Write Procedure section) to perform a write.
 - 13c. Send a repeated start condition (while holding the I2C_SCL line high, pull the I2C_SDA line low) and continue with Step 2 of this procedure to perform a read from another address.
 - 13d. Send a repeated start condition (while holding the I2C_SCL line high, pull the I2C_SDA line low) and continue with Step 8 of this procedure to perform a read from the same address.

SWITCHING/UPDATE DELAY

There is a delay between when a user writes to the configuration registers of the AD8197 and when that state change takes physical effect. This update delay occurs regardless of whether the user programs the AD8197 via the serial or the parallel control interface. When using the serial control interface, the update delay begins at the falling edge of I2C_SCL for the last data bit transferred, as shown in Figure 29. When using the parallel control interface, the update delay begins at the transition edge of the relevant parallel interface pin. This update delay is register specific and the times are specified in Table 1.

During a delay window, new values can be written to the configuration registers, but the AD8197 does not physically update until the end of that register's delay window. Writing new values during the delay window does not reset the window; new values supersede the previously written values. At the end of the delay window, the AD8197 physically assumes the state indicated by the last set of values written to the configuration registers. If the configuration registers are written after the delay window ends, the AD8197 immediately updates and a new delay window begins.

PARALLEL CONTROL INTERFACE

The AD8197 can be controlled through the parallel interface using the PP_EN, PP_CH[1:0], PP_EQ, PP_PRE[1:0], PP_OTO, and PP_OCL pins. Logic levels for the parallel interface pins are set in accordance with the specifications listed in Table 1. Setting these pins updates the parallel control interface registers, as listed in Table 24. Following a reset, the AD8197 can be controlled through the parallel control interface until the first serial control event occurs. As soon as any serial control

event occurs, the serial programming values override any prior parallel programming values, and the parallel control interface is disabled until the part is subsequently reset. The default serial programming values correspond to the state of the serial interface configuration registers, as listed in Table 5.

SERIAL INTERFACE CONFIGURATION REGISTERS

The serial interface configuration registers can be read and written using the I²C serial control interface, Pin I2C_SDA, and Pin I2C_SCL. The least significant bits of the AD8197 I²C part address are set by tying the Pin I2C_ADDR2, Pin I2C_ADDR1, and Pin I2C_ADDR0 to 3.3 V (Logic 1) or 0 V (Logic 0). As soon as the serial control interface is used, the parallel control interface is disabled until the AD8197 is reset as described in the Serial Control Interface section.

Table 5. Serial (I²C) Interface Register Map

Name	Bit 7	Bit 6	Bit 5	Bit 4	Bit 3	Bit 2	Bit 1	Bit 0	Addr.	Default
High Speed Device Modes		High speed switch enable	High speed switching mode select		High speed source select				0x00	0x40
		HS_EN	HS_SM[1]	HS_SM[0]	HS_CH[3]	HS_CH[2]	HS_CH[1]	HS_CH[0]		
Auxiliary Device Modes		Auxiliary switch enable	Auxiliary switching mode select		Auxiliary switch source select				0x01	0x40
		AUX_EN	AUX_SM[1]	AUX_SM[0]	AUX_CH[3]	AUX_CH[2]	AUX_CH[1]	AUX_CH[0]		
Receiver Settings								High speed input termination select	0x10	0x01
								RX_TO		
Input Termination Pulse 1	Source A and Source B : input termination pulse-on-source switch select (disconnect termination for a short period of time)								0x11	0x00
		RX_PT[7]	RX_PT[6]	RX_PT[5]	RX_PT[4]	RX_PT[3]	RX_PT[2]	RX_PT[1]		
Input Termination Pulse 2	Source C and Source D: input termination pulse-on-source switch select (disconnect termination for a short period of time)								0x12	0x00
		RX_PT[15]	RX_PT[14]	RX_PT[13]	RX_PT[12]	RX_PT[11]	RX_PT[10]	RX_PT[9]		
Receive Equalizer 1	Source A and Source B: input equalization level select								0x13	0x00
		RX_EQ[7]	RX_EQ[6]	RX_EQ[5]	RX_EQ[4]	RX_EQ[3]	RX_EQ[2]	RX_EQ[1]		
Receive Equalizer 2	Source C and Source D: input equalization level select								0x14	0x00
		RX_EQ[15]	RX_EQ[14]	RX_EQ[13]	RX_EQ[12]	RX_EQ[11]	RX_EQ[10]	RX_EQ[9]		
Transmitter Settings					High speed output pre-emphasis level select		High speed output termination select	High speed output current level select	0x20	0x03
					TX_PE[1]	TX_PE[0]	TX_PTO	TX_OCL		

HIGH SPEED DEVICE MODES REGISTER

HS_EN: High Speed (TMDS) Channels Enable Bit

Table 6. HS_EN Description

HS_EN	Description
0	High speed channels off, low power/standby mode
1	High speed channels on

HS_SM[1:0]: High Speed (TMDS) Switching Mode Select Bus

Table 7. HS_SM Description

HS_SM[1:0]	Description
00	Quad mode, 4× [4:1]
01	Dual mode, 2× [8:1]
10	Single mode, 1× [16:1]
11	Illegal value; previous value of HS_SM[1:0] retained

HS_CH[3:0]: High Speed (TMDS) Switch Source Select Bus

Table 8. Quad Mode, 4× [4:1], High Speed Switch Mapping

HS_CH[3:0]	O[3:0]	Description
XX00	A[3:0]	High Speed Source A switched to output
XX01	B[3:0]	High Speed Source B switched to output
XX10	C[3:0]	High Speed Source C switched to output
XX11	D[3:0]	High Speed Source D switched to output

Table 9. Dual Mode, 2× [8:1], High Speed Switch Mapping

HS_CH[3:0]	O[3:2]	O[1:0]	Description
X000	A1	A0	The A0 and A1 high speed channels switched to output
X001	A3	A2	The A2 and A3 high speed channels switched to output
X010	B1	B0	The B0 and B1 high speed channels switched to output
X011	B3	B2	The B2 and B3 high speed channels switched to output
X100	C1	C0	The C0 and C1 high speed channels switched to output
X101	C3	C2	The C2 and C3 high speed channels switched to output
X110	D1	D0	The D0 and D1 high speed channels switched to output
X111	D3	D2	The D2 and D3 high speed channels switched to output

Table 10. Single Mode, 1× [16:1], High Speed Switch Mapping

HS_CH[3:0]	O[3:0]	Description
0000	A0	High Speed Channel A0 switched to output
0001	A1	High Speed Channel A1 switched to output
0010	A2	High Speed Channel A2 switched to output
0011	A3	High Speed Channel A3 switched to output
0100	B0	High Speed Channel B0 switched to output
0101	B1	High Speed Channel B1 switched to output
0110	B2	High Speed Channel B2 switched to output
0111	B3	High Speed Channel B3 switched to output
1000	C0	High Speed Channel C0 switched to output
1001	C1	High Speed Channel C1 switched to output
1010	C2	High Speed Channel C2 switched to output
1011	C3	High Speed Channel C3 switched to output
1100	D0	High Speed Channel D0 switched to output
1101	D1	High Speed Channel D1 switched to output
1110	D2	High Speed Channel D2 switched to output
1111	D3	High Speed Channel D3 switched to output

AUXILIARY DEVICE MODES REGISTER

AUX_EN: Auxiliary (Low Speed) Switch Enable Bit

Table 11. AUX_EN Description

AUX_EN	Description
0	Auxiliary switch off, no low speed input/output to low speed common input/output connection
1	Auxiliary switch on

AUX_SM[1:0]: Auxiliary (Low Speed) Switching Mode Select Bus

Table 12. AUX_SM[1:0] Description

AUX_SM[1:0]	Description
00	Quad Mode, 4× [4:1]
01	Dual Mode, 2× [8:1]
10	Single Mode, 1× [6:1]
11	Illegal value; previous value of AUX_SM[1:0] retained

AUX_CH[3:0]: Auxiliary (Low Speed) Switch Source Select Bus

Table 13. Quad Mode, 4× [4:1], Auxiliary Switch Mapping

AUX_CH[3:0]	AUX_COM[3:0]	Description
XX00	AUX_A[3:0]	Auxiliary Source A switched to output
XX01	AUX_B[3:0]	Auxiliary Source B switched to output
XX10	AUX_C[3:0]	Auxiliary Source C switched to output
XX11	AUX_D[3:0]	Auxiliary Source D switched to output

Table 14. Dual Mode, 2× [8:1], Auxiliary Switch Mapping

AUX_CH[3:0]	AUX_COM[3:2]	AUX_COM[1:0]	Description
X000	AUX_C0	AUX_A0	The A0 and C0 auxiliary channels switched to output
X001	AUX_C1	AUX_A1	The A1 and C1 auxiliary channels switched to output
X010	AUX_C2	AUX_A2	The A2 and C2 auxiliary channels switched to output
X011	AUX_C3	AUX_A3	The A3 and C3 auxiliary channels switched to output
X100	AUX_D0	AUX_B0	The B0 and D0 auxiliary channels switched to output
X101	AUX_D1	AUX_B1	The B1 and D1 auxiliary channels switched to output
X110	AUX_D2	AUX_B2	The B2 and D2 auxiliary channels switched to output
X111	AUX_D3	AUX_B3	The B3 and D3 auxiliary channels switched to output

Table 15. Single Mode, 1× [16:1], Auxiliary Switch Mapping

AUX_CH[3:0]	AUX_COM[3:0]	Description
0000	AUX_A0	Auxiliary Channel A0 switched to output
0001	AUX_A1	Auxiliary Channel A1 switched to output
0010	AUX_A2	Auxiliary Channel A2 switched to output
0011	AUX_A3	Auxiliary Channel A3 switched to output
0100	AUX_B0	Auxiliary Channel B0 switched to output
0101	AUX_B1	Auxiliary Channel B1 switched to output
0110	AUX_B2	Auxiliary Channel B2 switched to output
0111	AUX_B3	Auxiliary Channel B3 switched to output
1000	AUX_C0	Auxiliary Channel C0 switched to output
1001	AUX_C1	Auxiliary Channel C1 switched to output
1010	AUX_C2	Auxiliary Channel C2 switched to output
1011	AUX_C3	Auxiliary Channel C3 switched to output
1100	AUX_D0	Auxiliary Channel D0 switched to output
1101	AUX_D1	Auxiliary Channel D1 switched to output
1110	AUX_D2	Auxiliary Channel D2 switched to output
1111	AUX_D3	Auxiliary Channel D3 switched to output

RECEIVER SETTINGS REGISTER

RX_TO: High Speed (TMDS) Channels Input Termination On/Off Select Bit

Table 16. RX_TO Description

RX_TO	Description
0	Input termination off
1	Input termination on (can be pulsed on and off according to settings in the input termination pulse register)

INPUT TERMINATION PULSE REGISTER 1 AND REGISTER 2

RX_PT[X]: High Speed (TMDS) Input Channel X Pulse-On-Source Switch Select Bit

Table 17. RX_PT[X] Description

RX_PT[X]	Description
0	Input termination for TMDS Channel X always connected when source is switched
1	Input termination for TMDS Channel X disconnected for 100 ms when source switched

Table 18. RX_PT[X] Mapping

RX_PT[X]	Corresponding Input TMDS Channel
Bit 0	B0
Bit 1	B1
Bit 2	B2
Bit 3	B3
Bit 4	A0
Bit 5	A1
Bit 6	A2
Bit 7	A3
Bit 8	C3
Bit 9	C2
Bit 10	C1
Bit 11	C0
Bit 12	D3
Bit 13	D2
Bit 14	D1
Bit 15	D0

RECEIVE EQUALIZER REGISTER 1 AND REGISTER 2

RX_EQ[X]: High Speed (TMDS) Input X Equalization Level Select Bit

Table 19. RX_EQ[X] Description

RX_EQ[X]	Description
0	Low equalization (6 dB)
1	High equalization (12 dB)

Table 20. RX_EQ[X] Mapping

RX_EQ[X]	Corresponding Input TMDS Channel
Bit 0	B0
Bit 1	B1
Bit 2	B2
Bit 3	B3
Bit 4	A0
Bit 5	A1
Bit 6	A2
Bit 7	A3
Bit 8	C3
Bit 9	C2
Bit 10	C1
Bit 11	C0
Bit 12	D3
Bit 13	D2
Bit 14	D1
Bit 15	D0

TRANSMITTER SETTINGS REGISTER

TX_PE[1:0]: High Speed (TMDS) Output Pre-Emphasis Level Select Bus (For All TMDS Channels)

Table 21. TX_PE[1:0] Description

TX_PE[1:0]	Description
00	No pre-emphasis (0 dB)
01	Low pre-emphasis (2 dB)
10	Medium pre-emphasis (4 dB)
11	High pre-emphasis (6 dB)

TX_PTO: High Speed (TMDS) Output Termination On/Off Select Bit (For All Channels)

Table 22. TX_PTO Description

TX_PTO	Description
0	Output termination off
1	Output termination on

TX_OCL: High Speed (TMDS) Output Current Level Select Bit (For All Channels)

Table 23. TX_OCL Description

TX_OCL	Description
0	Output current set to 10 mA
1	Output current set to 20 mA

PARALLEL INTERFACE CONFIGURATION REGISTERS

The parallel interface configuration registers can be directly set using the PP_EN, PP_CH[1:0], PP_EQ, PP_PRE[1:0], PP_OTO, and PP_OCL pins. This interface is only accessible after the part is reset and before any registers are accessed using the serial control interface. The state of each pin is set by tying it to 3.3 V (Logic 1) or 0 V (Logic 0).

Table 24. Parallel Interface Register Map

Name	Bit 7	Bit 6	Bit 5	Bit 4	Bit 3	Bit 2	Bit 1	Bit 0
High Speed Device Modes		High speed switch enable	High speed switching mode select (quad)		High speed source select			
	PP_EN	0	0	0	0	PP_CH[1]	PP_CH[0]	
Auxiliary Device Modes		Auxiliary switch enable	Auxiliary switching mode select (quad)		Auxiliary switch source select			
	1	0	0	0	0	PP_CH[1]	PP_CH[0]	
Receiver Settings								Input term. on/off select (termination always on)
								1
Input Termination Pulse 1	Source A and Source B input termination pulse-on-source switch select (termination always on)							
	0	0	0	0	0	0	0	0
Input Termination Pulse 2	Source C and Source D input termination pulse-on-source switch select (termination always on)							
	0	0	0	0	0	0	0	0
Receive Equalizer 1	Source A and Source B input equalization level select							
	PP_EQ	PP_EQ	PP_EQ	PP_EQ	PP_EQ	PP_EQ	PP_EQ	PP_EQ
Receive Equalizer 2	Source C and Source D input equalization level select							
	PP_EQ	PP_EQ	PP_EQ	PP_EQ	PP_EQ	PP_EQ	PP_EQ	PP_EQ
Transmitter Settings					Output pre-emphasis level select		Output termination on/off select	Output current level select
					PP_PE[1]	PP_PE[0]	PP_OTO	PP_OCL

HIGH SPEED DEVICE MODES REGISTER

The high speed (TMDS) switching mode is fixed to quad mode when using the parallel interface.

PP_EN: High Speed (TMDS) Channels Enable Bit

Table 25. PP_EN Description

PP_EN	Description
0	High speed channels off, low power/standby mode
1	High speed channels on

PP_CH[1:0]: High Speed (TMDS) Switch Source Select Bus

Table 26. Quad High speed Switch Mode Mapping

PP_CH[1:0]	O[3:0]	Description
00	A[3:0]	High Speed Source A switched to output
01	B[3:0]	High Speed Source B switched to output
10	C[3:0]	High Speed Source C switched to output
11	D[3:0]	High Speed Source D switched to output

AUXILIARY DEVICE MODES REGISTER

The auxiliary (low speed) switch is always enabled and the auxiliary switching mode is fixed to quad mode when using the parallel interface.

PP_CH[1:0]: Auxiliary Switch Source Select Bus

Table 27. Quad Auxiliary Switch Mode Mapping

PP_CH[1:0]	AUX_COM[3:0]	Description
00	AUX_A[3:0]	Auxiliary Source A switched to output
01	AUX_B[3:0]	Auxiliary Source B switched to output
10	AUX_C[3:0]	Auxiliary Source C switched to output
11	AUX_D[3:0]	Auxiliary Source D switched to output

RECEIVER SETTINGS REGISTER

High speed (TMDS) channels input termination is fixed to on when using the parallel interface.

INPUT TERMINATION PULSE REGISTER 1 AND REGISTER 2

High speed input (TMDS) channels pulse-on-source switching fixed to off when using the parallel interface.

RECEIVE EQUALIZER REGISTER 1 AND REGISTER 2

PP_EQ: High Speed (TMDS) Inputs Equalization Level Select Bit (For All TMDS Input Channels)

The input equalization cannot be set individually (per channel) when using the parallel interface; one equalization setting affects all input channels.

Table 28. PP_EQ Description

PP_EQ	Description
0	Low equalization (6 dB)
1	High equalization (12 dB)

TRANSMITTER SETTINGS REGISTER

PP_PE[1:0]: High Speed (TMDS) Output Pre-Emphasis Level Select Bus (For All TMDS Channels)

Table 29. PP_PE[1:0] Description

PP_PE[1:0]	Description
00	No pre-emphasis (0 dB)
01	Low pre-emphasis (2 dB)
10	Medium pre-emphasis (4 dB)
11	High pre-emphasis (6 dB)

PP_OTO: High Speed (TMDS) Output Termination On/Off Select Bit (For All TMDS Channels)

Table 30. PP_OTO Description

PP_OTO	Description
0	Output termination off
1	Output termination on

PP_OCL: High Speed (TMDS) Output Current Level Select Bit (For All TMDS Channels)

Table 31. TX_OCL Description

PP_OCL	Description
0	Output current set to 10 mA
1	Output current set to 20 mA

APPLICATION INFORMATION

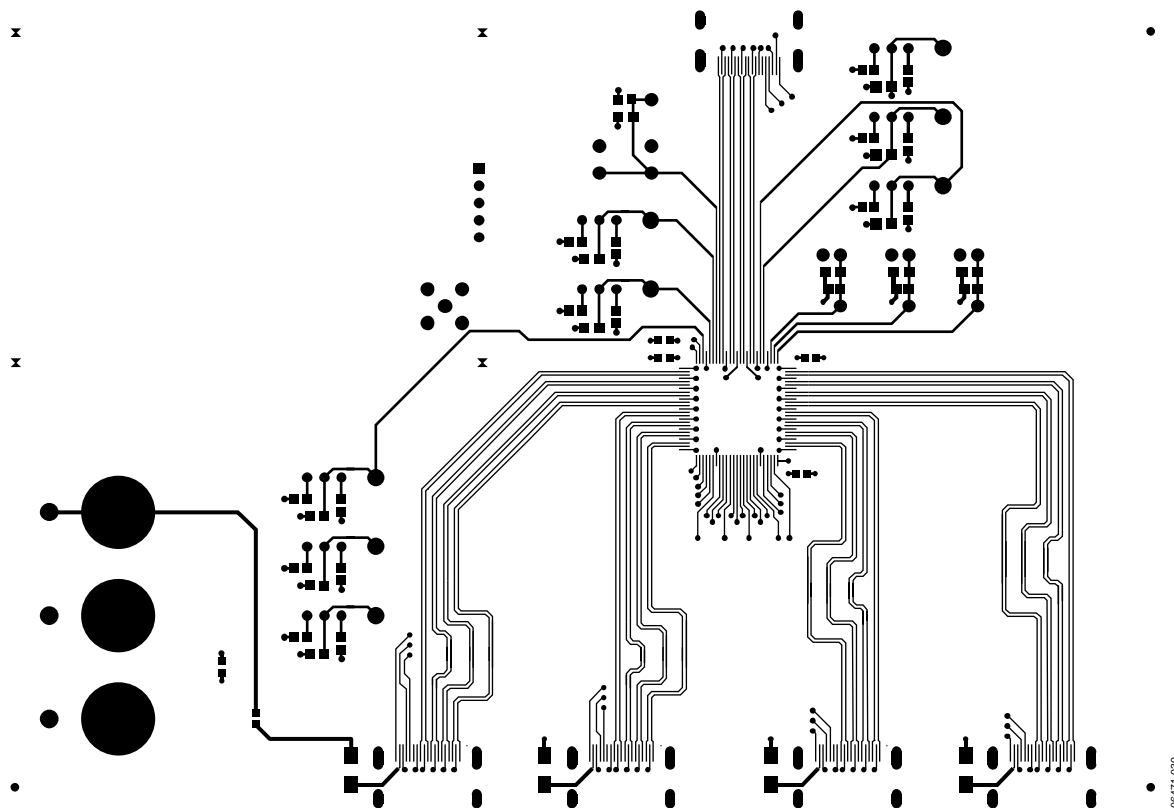

Figure 31. Layout of the TMDS Traces on the AD8197 Evaluation Board (Only Top Signal Routing Layer is Shown)

The AD8197 is an HDMI/DVI switch, featuring equalized TMDS inputs and pre-emphasized TMDS outputs. It is intended for use as a 4:1 switch in systems with long cable runs on both the input and/or the output, and is fully HDMI 1.3 receive-compliant.

PINOUT

The AD8197 is designed to have an HDMI/DVI receiver pinout at its input and a transmitter pinout at its output. This makes the AD8197 ideal for use in AVR-type applications where a designer routes both the inputs and the outputs directly to HDMI/DVI connectors, as shown in Figure 31. When the AD8197 is used in receiver type applications, it is necessary to change the order of the output pins on the PCB to align with the on-board receiver.

One advantage of the AD8197 in an AVR-type application is that all of the high speed signals can be routed on one side (the topside) of the board, as shown in Figure 31. In addition to 12 dB of input equalization, the AD8197 provides up to 6 dB of output pre-emphasis that boosts the output TMDS signals and allows the AD8197 to precompensate when driving long PCB traces or output cables. The net effect of the input equalization and output pre-emphasis of the AD8197 is that the AD8197 can compensate for the signal degradation of both input and output

cables; it acts to reopen a closed input data eye and transmit a full-swing HDMI signal to an end receiver. More information on the specific performance metrics of the AD8197 can be found in the Typical Performance Characteristics section.

The AD8197 also provides a distinct advantage in receive-type applications because it is a fully buffered HDMI/DVI switch. Although inverting the output pin order of the AD8197 on the PCB requires a designer to place vias in the high speed signal path, the AD8197 fully buffers and electrically decouples the outputs from the inputs. Therefore, the effects of the vias placed on the output signal lines are not seen at the input of the AD8197. The programmable output terminations also improve signal quality at the output of the AD8197. The PCB designer, therefore, has significantly improved flexibility in the placement and routing of the output signal path with the AD8197 over other solutions.

CABLE LENGTHS AND EQUALIZATION

The AD8197 offers two levels of programmable equalization for the high speed inputs: 6 dB and 12 dB. The equalizer of the AD8197 supports video data rates of up to 2.25 Gbps, and as shown in Figure 14, it can equalize more than 20 meters of 24 AWG HDMI cable at 2.25 Gbps, which corresponds to the video format, 1080p with deep color.

The length of cable that can be used in a typical HDMI/DVI application depends on a large number of factors, including:

- Cable quality: the quality of the cable in terms of conductor wire gauge and shielding. Thicker conductors have lower signal degradation per unit length.
- Data rate: the data rate being sent over the cable. The signal degradation of HDMI cables increases with data rate.
- Edge rates: the edge rates of the source input. Slower input edges result in more significant data eye closure at the end of a cable.
- Receiver sensitivity: the sensitivity of the terminating receiver.

As such, specific cable types and lengths are not recommended for use with a particular equalizer setting. In nearly all applications, the AD8197 equalization level can be set to high, or 12 dB, for all input cable configurations at all data rates, without degrading the signal integrity.

PCB LAYOUT GUIDELINES

The AD8197 is used to switch two distinctly different types of signals, both of which are required for HDMI and DVI video. These signal groups require different treatment when laying out a PC board.

The first group of signals carries the audiovisual (AV) data. HDMI/DVI video signals are differential, unidirectional, and high speed (up to 2.25 Gbps). The channels that carry the video data must be controlled impedance, terminated at the receiver, and capable of operating at the maximum specified system data rate. It is especially important to note that the differential traces that carry the TMDS signals should be designed with a controlled differential impedance of 100 Ω . The AD8197 provides single-ended, 50 Ω terminations on-chip for both its inputs and outputs, and both the input and output terminations can be enabled or disabled through the serial control interface. The output terminations can also be enabled or disabled through the parallel control interface. Transmitter termination is not required by the HDMI 1.3 standard, but its inclusion improves the overall system signal integrity.

The audiovisual (AV) data carried on these high speed channels is encoded by a technique called transmission minimized differential signaling (TMDS) and in the case of HDMI, is also encrypted according to the high bandwidth digital copy protection (HDCP) standard.

The second group of signals consists of low speed auxiliary control signals used for communication between a source and a sink. Depending upon the application, these signals can include the DDC bus (this is an I²C bus used to send EDID information and HDCP encryption keys between the source and the sink), the consumer electronics control (CEC) line, and the hot plug detect (HPD) line. These auxiliary signals are bidirectional, low speed, and transferred over a single-ended transmission line that does not need to have controlled impedance. The primary concern with laying out the auxiliary lines is ensuring that they

conform to the I²C bus standard and do not have excessive capacitive loading.

TMDS Signals

In the HDMI/DVI standard, four differential pairs carry the TMDS signals. In DVI, three of these pairs are dedicated to carrying RGB video and sync data. For HDMI, audio data is interleaved with the video data; the DVI standard does not incorporate audio information. The fourth high speed differential pair is used for the AV data-word clock, and runs at one-tenth the speed of the TMDS data channels.

The four high speed channels of the AD8197 are identical. No concession was made to lower the bandwidth of the fourth channel for the pixel clock, so any channel can be used for any TMDS signal. The user chooses which signal is routed over which channel. Additionally, the TMDS channels are symmetrical; therefore, the p and n of a given differential pair are interchangeable, provided the inversion is consistent across all inputs and outputs of the AD8197. However, the routing between inputs and outputs through the AD8197 is fixed. For example, in quad mode, Output Channel 0 always switches between Input A0, Input B0, Input C0, Input D0, and so forth.

The AD8197 buffers the TMDS signals and the input traces can be considered electrically independent of the output traces. In most applications, the quality of the signal on the input TMDS traces is more sensitive to the PCB layout. Regardless of the data being carried on a specific TMDS channel, or whether the TMDS line is at the input or the output of the AD8197, all four high speed signals should be routed on a PCB in accordance with the same RF layout guidelines.

Layout for the TMDS Signals

The TMDS differential pairs can be either microstrip traces, routed on the outer layer of a board, or stripline traces, routed on an internal layer of the board. If microstrip traces are used, there should be a continuous reference plane on the PCB layer directly below the traces. If stripline traces are used, they must be sandwiched between two continuous reference planes in the PCB stack-up. Additionally, the p and n of each differential pair must have a controlled differential impedance of 100 Ω . The characteristic impedance of a differential pair is a function of several variables including the trace width, the distance separating the two traces, the spacing between the traces and the reference plane, and the dielectric constant of the PC board binder material. Interlayer vias introduce impedance discontinuities that can cause reflections and jitter on the signal path, therefore, it is preferable to route the TMDS lines exclusively on one layer of the board, particularly for the input traces. In some applications, such as using multiple AD8197s to construct large input arrays, the use of interlayer vias becomes unavoidable. In these situations, the input termination feature of the AD8197 improves system signal integrity by absorbing reflections. Take care to use vias minimally and to place vias symmetrically for each side of a given differential pair. Furthermore, to prevent unwanted signal coupling and

interference, route the TMDS signals away from other signals and noise sources on the PCB.

Both traces of a given differential pair must be equal in length to minimize intrapair skew. Maintaining the physical symmetry of a differential pair is integral to ensuring its signal integrity; excessive intrapair skew can introduce jitter through duty cycle distortion (DCD). The p and n of a given differential pair should always be routed together to establish the required 100 Ω differential impedance. Enough space should be left between the differential pairs of a given group so that the n of one pair does not couple to the p of another pair. For example, one technique is to make the interpair distance 4 to 10 times wider than the intrapair spacing.

Any group of four TMDS channels (Input A, Input B, Input C, Input D, or the output) should have closely matched trace lengths to minimize interpair skew. Severe interpair skew can cause the data on the four different channels of a group to arrive out of alignment with one another. A good practice is to match the trace lengths for a given group of four channels to within 0.05 inches on FR4 material.

Minimizing intrapair and interpair skew becomes increasingly important as data rates increase. Any introduced skew will constitute a correspondingly larger fraction of a bit period at higher data rates.

Though the AD8197 features input equalization and output pre-emphasis, the length of the TMDS traces should be minimized to reduce overall signal degradation. Commonly used PC board material such as FR4 is lossy at high frequencies; therefore, long traces on the circuit board increase signal attenuation resulting in decreased signal swing and increased jitter through intersymbol interference (ISI).

Controlling the Characteristic Impedance of a TMDS Differential Pair

The characteristic impedance of a differential pair depends on a number of variables, including the trace width, the distance between the two traces, the height of the dielectric material between the trace and the reference plane below it, and the dielectric constant of the PCB binder material. To a lesser extent, the characteristic impedance also depends upon the trace thickness and the presence of solder mask. There are many combinations that can produce the correct characteristic impedance. Generally, working with the PC board fabricator is required to obtain a set of parameters to produce the desired results.

One consideration is how to guarantee a differential pair with a differential impedance of 100 Ω over the entire length of the trace. One technique to accomplish this is to change the width of the traces in a differential pair based on how closely one trace is coupled to the other. When the two traces of a differential pair are close and strongly coupled, they should have a width that produces a 100 Ω differential impedance. When the traces split apart, to go into a connector, for example, and are no

longer so strongly coupled, the width of the traces should be increased to yield a differential impedance of 100 Ω in the new configuration.

Ground Current Return

In some applications, it can be necessary to invert the output pin order of the AD8197. This requires a designer to route the TMDS traces on multiple layers of the PCB. When routing differential pairs on multiple layers, it is also necessary to reroute the corresponding reference plane in order to provide one continuous ground current return path for the differential signals. Standard plated through-hole vias are acceptable for both the TMDS traces and the reference plane. An example of this is illustrated in Figure 32.

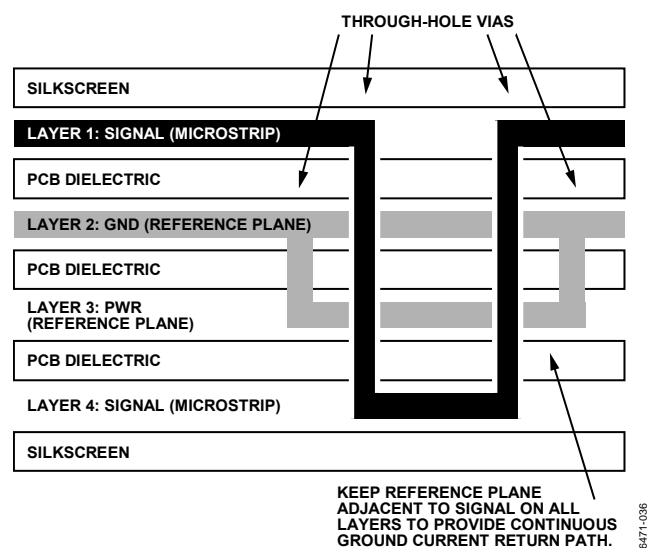

Figure 32. Example Routing of Reference Plane

TMDS Terminations

The AD8197 provides internal, 50 Ω single-ended terminations for all of its high speed inputs and outputs. It is not necessary to include external termination resistors for the TMDS differential pairs on the PCB.

The output termination resistors of the AD8197 back-terminate the output TMDS transmission lines. These back-terminations act to absorb reflections from impedance discontinuities on the output traces, improving the signal integrity of the output traces and adding flexibility to how the output traces can be routed. For example, interlayer vias can be used to route the AD8197 TMDS outputs on multiple layers of the PCB without severely degrading the quality of the output signal.

Auxiliary Control Signals

There are four single-ended control signals associated with each source or sink in an HDMI/DVI application. These are hot plug detect (HPD), consumer electronics control (CEC), and two display data channel (DDC) lines. The two signals on the DDC bus are SDA and SCL (serial data and serial clock, respectively). These four signals can be switched through the auxiliary bus of

AD8197

the AD8197 and do not need to be routed with the same strict considerations as the high speed TMDS signals.

In general, it is sufficient to route each auxiliary signal as a single-ended trace. These signals are not sensitive to impedance discontinuities, do not require a reference plane, and can be routed on multiple layers of the PCB. However, it is best to follow strict layout practices whenever possible to prevent the PCB design from affecting the overall application. The specific routing of the HPD, CEC, and DDC lines depends upon the application in which the AD8197 is being used.

For example, the maximum speed of signals present on the auxiliary lines is 100 kHz I²C data on the DDC lines; therefore, any layout that enables 100 kHz I²C to be passed over the DDC bus should suffice. The HDMI 1.3 specification, however, places a strict 50 pF limit on the amount of capacitance that can be measured on either SDA or SCL at the HDMI input connector. This 50 pF limit includes the HDMI connector, the PCB, and whatever capacitance is seen at the input of the AD8197, or an equivalent receiver. There is a similar limit of 100 pF of input capacitance for the CEC line.

The parasitic capacitance of traces on a PCB increases with trace length. To help ensure that a design satisfies the HDMI specification, the length of the CEC and DDC lines on the PCB should be made as short as possible. Additionally, if there is a reference plane in the layer adjacent to the auxiliary traces in the PCB stack-up, relieving or clearing out this reference plane immediately under the auxiliary traces significantly decreases the amount of parasitic trace capacitance. An example of the board stackup is shown in Figure 33.

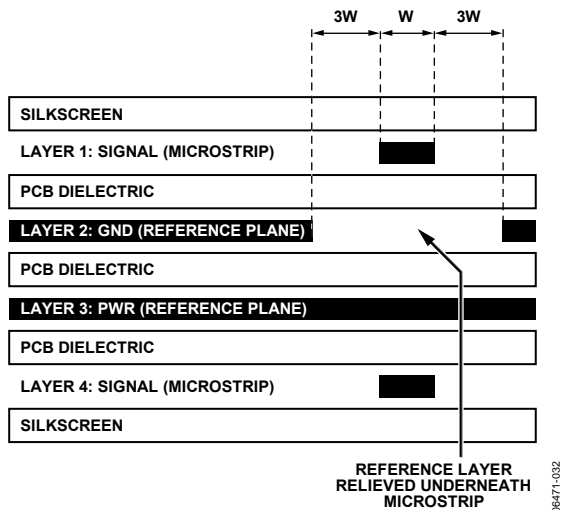

Figure 33. Example Board Stackup

HPD is a dc signal presented by a sink to a source to indicate that the source EDID is available for reading. The placement of this signal is not critical, but it should be routed as directly as possible.

When the AD8197 is powered up, one set of the auxiliary inputs is passively routed to the outputs. In this state, the AD8197 looks like a 100 Ω resistor between the selected auxiliary inputs and the corresponding outputs as illustrated in Figure 27. The AD8197 does not buffer the auxiliary signals, therefore, the input traces, output traces, and the connection through the AD8197 all must be considered when designing a PCB to meet HDMI/DVI specifications. The unselected auxiliary inputs of the AD8197 are placed into a high impedance mode when the device is powered up. To ensure that all of the auxiliary inputs of the AD8197 are in a high impedance mode when the device is powered off, it is necessary to power the AMUXVCC supply as illustrated in Figure 28.

In contrast to the auxiliary signals, the AD8197 buffers the TMDS signals, allowing a PCB designer to layout the TMDS inputs independently of the outputs.

Power Supplies

The AD8197 has five separate power supplies referenced to two separate grounds. The supply/ground pairs are:

- AVCC/AVEE
- VTTI/AVEE
- VTTO/AVEE
- DVCC/DVEE
- AMUXVCC/DVEE

The AVCC/AVEE (3.3 V) and DVCC/DVEE (3.3 V) supplies power the core of the AD8197. The VTTI/AVEE supply (3.3 V) powers the input termination (see Figure 25). Similarly, the VTTO/AVEE supply (3.3 V) powers the output termination (see Figure 26). The AMUXVCC/DVEE supply (3.3 V to 5 V) powers the auxiliary multiplexer core and determines the maximum allowed voltage on the auxiliary lines. For example, if the DDC bus is using 5 V I²C, then AMUXVCC should be connected to +5 V relative to DVEE.

In a typical application, all pins labeled AVEE or DVEE should be connected directly to ground. All pins labeled AVCC, DVCC, VTTI, or VTTO should be connected to 3.3 V, and Pin AMUXVCC tied to 5 V. The supplies can also be powered individually, but care must be taken to ensure that each stage of the AD8197 is powered correctly.

Power Supply Bypassing

The AD8197 requires minimal supply bypassing. When powering the supplies individually, place a 0.01 μF capacitor between each 3.3 V supply pin (AVCC, DVCC, VTTI, and VTTO) and ground to filter out supply noise. Generally, bypass capacitors should be placed near the power pins and should connect directly to the relevant supplies (without long intervening traces). For example, to improve the parasitic inductance of the power supply decoupling capacitors, minimize the trace length between capacitor landing pads and the vias as shown in Figure 34.

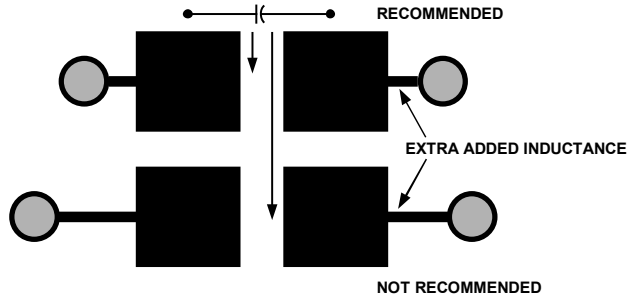

Figure 34. Recommended Pad Outline for Bypass Capacitors

In applications where the AD8197 is powered by a single 3.3 V supply, it is recommended to use two reference supply planes

and bypass the 3.3 V reference plane to the ground reference plane with one 220 pF, one 1000 pF, two 0.01 μF , and one 4.7 μF capacitors. The capacitors should via down directly to the supply planes and be placed within a few centimeters of the AD8197. The AMUXVCC supply does not require additional bypassing. This bypassing scheme is illustrated in Figure 35.

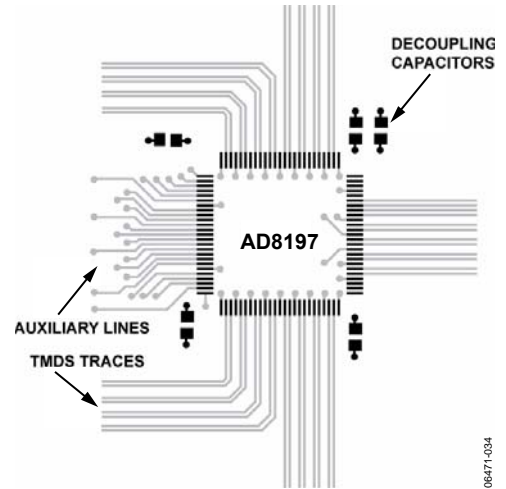
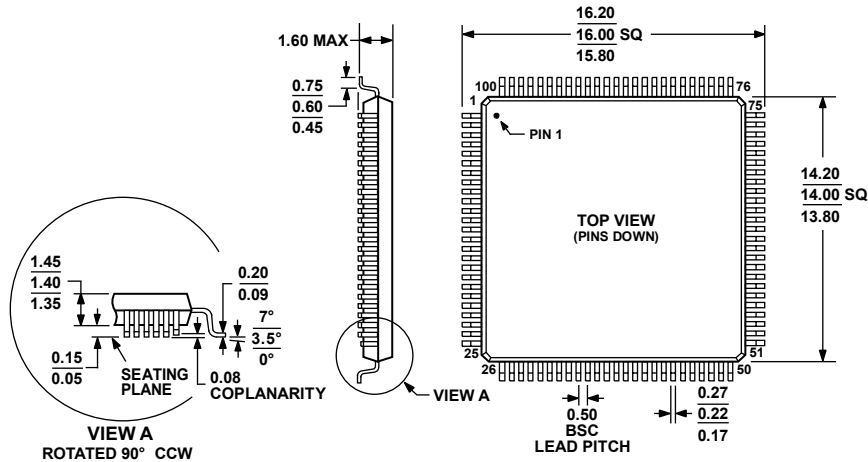

Figure 35. Example Placement of Power Supply Decoupling Capacitors Around the AD8197

OUTLINE DIMENSIONS



COMPLIANT TO JEDEC STANDARDS MS-026-BED

Figure 36. 100-Lead Low Profile Quad Flat Package [LQFP] (ST-100)

Dimensions shown in millimeters

051706-A

ORDERING GUIDE

Model	Temperature Range	Package Description	Package Option	Ordering Quantity
AD8197ASTZ ¹	-40°C to +85°C	100-Lead Low Profile Quad Flat Package [LQFP]	ST-100	
AD8197ASTZ-R7 ¹	-40°C to +85°C	100-Lead Low Profile Quad Flat Package [LQFP], Reel	ST-100	1,000
AD8197-EVAL		Evaluation Board		

¹ Z = Pb-free part.

NOTES

AD8197

NOTES